

**Elektrische Eigenschaften / Electrical properties**

**Höchstzulässige Werte / Maximum rated values**

**Diode Gleichrichter/ Diode Rectifier**

Periodische Rückw. Spitzenspernung repetitive peak reverse voltage		$V_{RRM}$	1600	V
Durchlaßstrom Grenzeffektivwert RMS forward current per chip		$I_{FRMSM}$	40	A
Dauergleichstrom DC forward current	$T_C = 80^\circ C$	$I_d$	35	A
Stoßstrom Grenzwert surge forward current	$t_p = 10\text{ ms}, T_{vj} = 25^\circ C$ $t_p = 10\text{ ms}, T_{vj} = 150^\circ C$	$I_{FSM}$	315 260	A A
Grenzlastintegral $I^2t$ - value	$t_p = 10\text{ ms}, T_{vj} = 25^\circ C$ $t_p = 10\text{ ms}, T_{vj} = 150^\circ C$	$I^2t$	500 340	$A^2s$ $A^2s$

**Transistor Wechselrichter/ Transistor Inverter**

Kollektor-Emitter-Spernung collector-emitter voltage		$V_{CES}$	1200	V
Kollektor-Dauergleichstrom DC-collector current	$T_C = 80^\circ C$ $T_C = 25^\circ C$	$I_{C,nom.}$ $I_C$	35 45	A A
Periodischer Kollektor Spitzenstrom repetitive peak collector current	$t_p = 1\text{ ms}, T_C = 80^\circ C$	$I_{CRM}$	70	A
Gesamt-Verlustleistung total power dissipation	$T_C = 25^\circ C$	$P_{tot}$	230	W
Gate-Emitter-Spernung gate-emitter peak voltage		$V_{GES}$	+/- 20V	V

**Diode Wechselrichter/ Diode Inverter**

Dauergleichstrom DC forward current	$T_C = 80^\circ C$	$I_F$	35	A
Periodischer Spitzenstrom repetitive peak forw. current	$t_p = 1\text{ ms}$	$I_{FRM}$	70	A
Grenzlastintegral $I^2t$ - value	$V_R = 0V, t_p = 10\text{ms}, T_{vj} = 125^\circ C$	$I^2t$	310	$A^2s$

**Transistor Brems-Chopper/ Transistor Brake-Chopper**

Kollektor-Emitter-Spernung collector-emitter voltage		$V_{CES}$	1200	V
Kollektor-Dauergleichstrom DC-collector current	$T_C = 80^\circ C$ $T_C = 25^\circ C$	$I_{C,nom.}$ $I_C$	17,5 35	A A
Periodischer Kollektor Spitzenstrom repetitive peak collector current	$t_p = 1\text{ ms}, T_C = 80^\circ C$	$I_{CRM}$	35	A
Gesamt-Verlustleistung total power dissipation	$T_C = 25^\circ C$	$P_{tot}$	180	W
Gate-Emitter-Spernung gate-emitter peak voltage		$V_{GES}$	+/- 20V	V

**Diode Brems-Chopper/ Diode Brake-Chopper**

Dauergleichstrom DC forward current	$T_C = 80^\circ C$	$I_F$	10	A
Periodischer Spitzenstrom repetitive peak forw. current	$t_p = 1\text{ ms}$	$I_{FRM}$	20	A

prepared by: Andreas Schulz	date of publication:29.03.2001
approved by: Robert Severin	revision: 3

# Technische Information / Technical Information

IGBT-Module  
IGBT-Modules

## BSM35GP120G

eupec

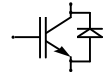

### Modul Isolation/ Module Isolation

Isolations-Prüfspannung insulation test voltage	RMS, f = 50 Hz, t = 1 min. NTC connected to Baseplate	$V_{ISOL}$	2,5	kV
--	--	------------	-----	----

### Elektrische Eigenschaften / Electrical properties

#### Charakteristische Werte / Characteristic values

##### Diode Gleichrichter/ Diode Rectifier

				min.	typ.	max.	
Durchlaßspannung forward voltage	$T_{vj} = 150^{\circ}\text{C}$ , $I_F = 35\text{ A}$	$V_F$	-	1,15	-	V	
Schleusenspannung threshold voltage	$T_{vj} = 150^{\circ}\text{C}$	$V_{(TO)}$	-	-	0,8	V	
Ersatzwiderstand slope resistance	$T_{vj} = 150^{\circ}\text{C}$	$r_T$	-	-	10,5	m $\Omega$	
Sperrstrom reverse current	$T_{vj} = 150^{\circ}\text{C}$ , $V_R = 1600\text{ V}$	$I_R$	-	2	-	mA	
Modul Leitungswiderstand, Anschlüsse-Chip lead resistance, terminals-chip	$T_C = 25^{\circ}\text{C}$	$R_{AA+CC}$	-	4	-	m $\Omega$	

##### Transistor Wechselrichter/ Transistor Inverter

				min.	typ.	max.	
Kollektor-Emitter Sättigungsspannung collector-emitter saturation voltage	$V_{GE} = 15\text{V}$ , $T_{vj} = 25^{\circ}\text{C}$ , $I_C = 35\text{ A}$	$V_{CE\text{ sat}}$	-	2,4	2,85	V	
	$V_{GE} = 15\text{V}$ , $T_{vj} = 125^{\circ}\text{C}$ , $I_C = 35\text{ A}$		-	2,9	-	V	
Gate-Schwellenspannung gate threshold voltage	$V_{CE} = V_{GE}$ , $T_{vj} = 25^{\circ}\text{C}$ , $I_C = 1\text{ mA}$	$V_{GE(TO)}$	4,5	5,5	6,5	V	
Eingangskapazität input capacitance	f = 1MHz, $T_{vj} = 25^{\circ}\text{C}$ $V_{CE} = 25\text{ V}$ , $V_{GE} = 0\text{ V}$	$C_{ies}$	-	1,5	-	nF	
Kollektor-Emitter Reststrom collector-emitter cut-off current	$V_{GE} = 0\text{V}$ , $T_{vj} = 25^{\circ}\text{C}$ , $V_{CE} = 1200\text{ V}$	$I_{CES}$	-	1,5	500	$\mu\text{A}$	
	$V_{GE} = 0\text{V}$ , $T_{vj} = 125^{\circ}\text{C}$ , $V_{CE} = 1200\text{ V}$		-	2,0	-	mA	
Gate-Emitter Reststrom gate-emitter leakage current	$V_{CE} = 0\text{V}$ , $V_{GE} = 20\text{V}$ , $T_{vj} = 25^{\circ}\text{C}$	$I_{GES}$	-	-	300	nA	
Einschaltverzögerungszeit (ind. Last) turn on delay time (inductive load)	$I_C = I_{Nenn}$ , $V_{CC} = 600\text{ V}$	$t_{d,on}$	-	50	-	ns	
	$V_{GE} = \pm 15\text{V}$ , $T_{vj} = 25^{\circ}\text{C}$ , $R_G = 22\text{ Ohm}$						
	$V_{GE} = \pm 15\text{V}$ , $T_{vj} = 125^{\circ}\text{C}$ , $R_G = 22\text{ Ohm}$						
Anstiegszeit (induktive Last) rise time (inductive load)	$I_C = I_{Nenn}$ , $V_{CC} = 600\text{ V}$	$t_r$	-	55	-	ns	
	$V_{GE} = \pm 15\text{V}$ , $T_{vj} = 25^{\circ}\text{C}$ , $R_G = 22\text{ Ohm}$						
	$V_{GE} = \pm 15\text{V}$ , $T_{vj} = 125^{\circ}\text{C}$ , $R_G = 22\text{ Ohm}$						
Abschaltverzögerungszeit (ind. Last) turn off delay time (inductive load)	$I_C = I_{Nenn}$ , $V_{CC} = 600\text{ V}$	$t_{d,off}$	-	290	-	ns	
	$V_{GE} = \pm 15\text{V}$ , $T_{vj} = 25^{\circ}\text{C}$ , $R_G = 22\text{ Ohm}$						
	$V_{GE} = \pm 15\text{V}$ , $T_{vj} = 125^{\circ}\text{C}$ , $R_G = 22\text{ Ohm}$						
Fallzeit (induktive Last) fall time (inductive load)	$I_C = I_{Nenn}$ , $V_{CC} = 600\text{ V}$	$t_f$	-	50	-	ns	
	$V_{GE} = \pm 15\text{V}$ , $T_{vj} = 25^{\circ}\text{C}$ , $R_G = 22\text{ Ohm}$						
	$V_{GE} = \pm 15\text{V}$ , $T_{vj} = 125^{\circ}\text{C}$ , $R_G = 22\text{ Ohm}$						
Einschaltverlustenergie pro Puls turn-on energy loss per pulse	$I_C = I_{Nenn}$ , $V_{CC} = 600\text{ V}$	$E_{on}$	-	4,5	-	mWs	
	$V_{GE} = \pm 15\text{V}$ , $T_{vj} = 125^{\circ}\text{C}$ , $R_G = 22\text{ Ohm}$						
	$L_S = 75\text{ nH}$						
Abschaltverlustenergie pro Puls turn-off energy loss per pulse	$I_C = I_{Nenn}$ , $V_{CC} = 600\text{ V}$	$E_{off}$	-	4,3	-	mWs	
	$V_{GE} = \pm 15\text{V}$ , $T_{vj} = 125^{\circ}\text{C}$ , $R_G = 22\text{ Ohm}$						
	$L_S = 75\text{ nH}$						
Kurzschlußverhalten SC Data	$t_P \leq 10\mu\text{s}$ , $V_{GE} \leq 15\text{V}$ , $T_{vj} \leq 125^{\circ}\text{C}$ , $R_G = 22\text{ Ohm}$ , $V_{CC} = 720\text{ V}$ , $di/dt = 2800\text{ A}/\mu\text{s}$	$I_{SC}$	-	160	-	A	



**Elektrische Eigenschaften / Electrical properties**

**Charakteristische Werte / Characteristic values**

			min.	typ.	max.	
Modulinduktivität stray inductance module		$L_{GCE}$	-	-	100	nH
Modul Leitungswiderstand, Anschlüsse-Chip lead resistance, terminals-chip	$T_C = 25^\circ C$	$R_{CC+EE}$	-	7	-	m $\Omega$
<b>Diode Wechselrichter/ Diode Inverter</b>			<b>min.</b>	<b>typ.</b>	<b>max.</b>	
Durchlaßspannung forward voltage	$V_{GE} = 0V, T_{vj} = 25^\circ C, I_F = 35 A$ $V_{GE} = 0V, T_{vj} = 125^\circ C, I_F = 35 A$	$V_F$	-	1,95 1,8	2,45 -	V V
Rückstromspitze peak reverse recovery current	$I_F = I_{Nenn}, -di_F/dt = 1400A/\mu s$ $V_{GE} = -10V, T_{vj} = 25^\circ C, V_R = 600 V$ $V_{GE} = -10V, T_{vj} = 125^\circ C, V_R = 600 V$	$I_{RM}$	-	40 45	- -	A A
Sperrverzögerungsladung recovered charge	$I_F = I_{Nenn}, -di_F/dt = 1400A/\mu s$ $V_{GE} = -10V, T_{vj} = 25^\circ C, V_R = 600 V$ $V_{GE} = -10V, T_{vj} = 125^\circ C, V_R = 600 V$	$Q_r$	-	3,5 7,5	- -	$\mu As$ $\mu As$
Abschaltenergie pro Puls reverse recovery energy	$I_F = I_{Nenn}, -di_F/dt = 1400A/\mu s$ $V_{GE} = -10V, T_{vj} = 25^\circ C, V_R = 600 V$ $V_{GE} = -10V, T_{vj} = 125^\circ C, V_R = 600 V$	$E_{RO}$	-	1,3 2,5	- -	mWs mWs
<b>Transistor Brems-Chopper/ Transistor Brake-Chopper</b>			<b>min.</b>	<b>typ.</b>	<b>max.</b>	
Kollektor-Emitter Sättigungsspannung collector-emitter saturation voltage	$V_{GE} = 15V, T_{vj} = 25^\circ C, I_C = 17,5 A$ $V_{GE} = 15V, T_{vj} = 125^\circ C, I_C = 17,5 A$	$V_{CE sat}$	-	2,3 2,7	2,75 -	V V
Gate-Schwellenspannung gate threshold voltage	$V_{CE} = V_{GE}, T_{vj} = 25^\circ C, I_C = 0,6mA$	$V_{GE(TO)}$	4,5	5,5	6,5	V
Eingangskapazität input capacitance	$f = 1MHz, T_{vj} = 25^\circ C$ $V_{CE} = 25 V, V_{GE} = 0 V$	$C_{ies}$	-	1,0	-	nF
Kollektor-Emitter Reststrom collector-emitter cut-off current	$V_{GE} = 0V, T_{vj} = 25^\circ C, V_{CE} = 1200 V$ $V_{GE} = 0V, T_{vj} = 125^\circ C, V_{CE} = 1200 V$	$I_{CES}$	-	1,0 1,2	500 -	$\mu A$ mA
Gate-Emitter Reststrom gate-emitter leakage current	$V_{CE} = 0V, V_{GE} = 20V, T_{vj} = 25^\circ C$	$I_{GES}$	-	-	300	nA
<b>Diode Brems-Chopper/ Diode Brake-Chopper</b>			<b>min.</b>	<b>typ.</b>	<b>max.</b>	
Durchlaßspannung forward voltage	$T_{vj} = 25^\circ C, I_F = 17,5 A$ $T_{vj} = 125^\circ C, I_F = 17,5 A$	$V_F$	-	2,7 2,6	3,05 -	V V
<b>NTC-Widerstand/ NTC-Thermistor</b>			<b>min.</b>	<b>typ.</b>	<b>max.</b>	
Nennwiderstand rated resistance	$T_C = 25^\circ C$	$R_{25}$	-	5	-	k $\Omega$
Abweichung von $R_{100}$ deviation of $R_{100}$	$T_C = 100^\circ C, R_{100} = 493 \Omega$	$\Delta R/R$	-5		5	%
Verlustleistung power dissipation	$T_C = 25^\circ C$	$P_{25}$			20	mW
B-Wert B-value	$R_2 = R_1 \exp [B(1/T_2 - 1/T_1)]$	$B_{25/50}$		3375		K

# Technische Information / Technical Information

IGBT-Module  
IGBT-Modules

## BSM35GP120G

eupec



### Thermische Eigenschaften / Thermal properties

			min.	typ.	max.	
Innerer Wärmewiderstand thermal resistance, junction to case	Gleicher. Diode/ Rectif. Diode	$R_{thJC}$	-	-	1	K/W
	Trans. Wechr./ Trans. Inverter		-	-	0,55	K/W
	Diode Wechr./ Diode Inverter		-	-	0,8	K/W
	Trans. Bremse/ Trans. Brake		-	-	0,7	K/W
	Diode Bremse/ Diode Brake		-	-	2,3	K/W
Übergangs-Wärmewiderstand thermal resistance, case to heatsink	Gleicher. Diode/ Rectif. Diode	$R_{thCK}$	-	0,04	-	K/W
	Trans. Wechr./ Trans. Inverter	$\lambda_{paste}=1W/m^2K$	-	0,02	-	K/W
	Diode Wechr./ Diode Inverter	$\lambda_{grease}=1W/m^2K$	-	0,04	-	K/W
Höchstzulässige Sperrschichttemperatur maximum junction temperature		$T_{vj}$	-	-	150	°C
Betriebstemperatur operation temperature		$T_{op}$	-40	-	125	°C
Lagertemperatur storage temperature		$T_{stg}$	-40	-	125	°C

### Mechanische Eigenschaften / Mechanical properties

Innere Isolation internal insulation				$Al_2O_3$	
CTI comperative tracking index				225	
Anzugsdrehmoment f. mech. Befestigung mounting torque		M		3 $\pm 10\%$	Nm
Gewicht weight		G		300	g



Ausgangskennlinienfeld Wechselr. (typisch)

$I_C = f(V_{CE})$

Output characteristic Inverter (typical)

$V_{GE} = 15\text{ V}$

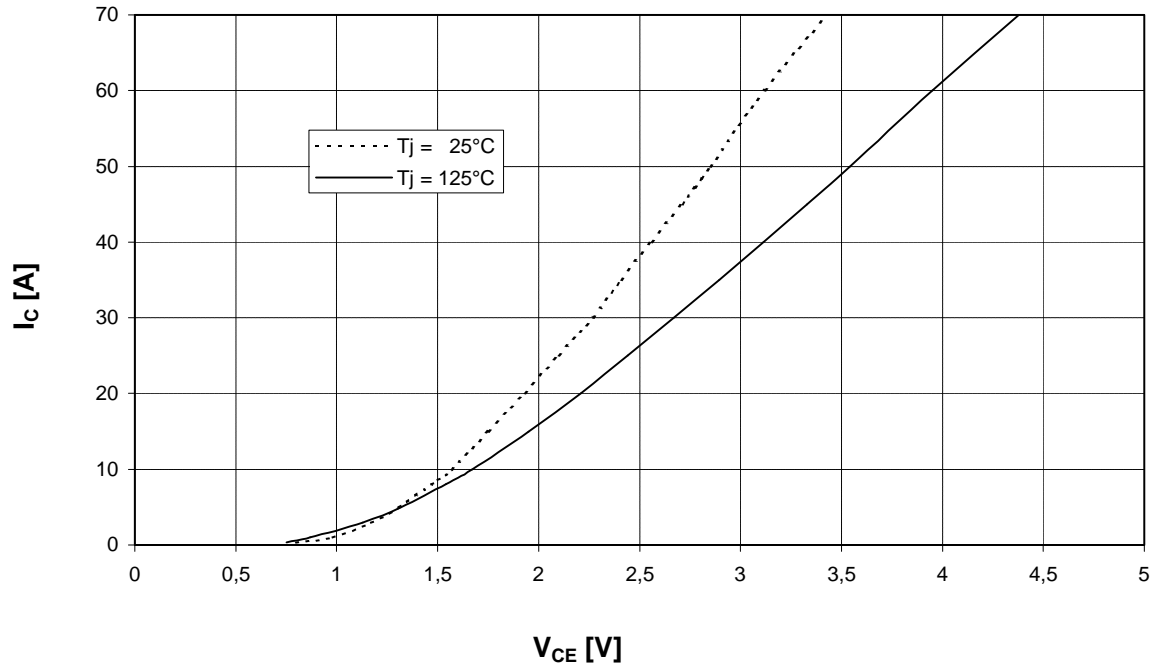

Ausgangskennlinienfeld Wechselr. (typisch)

$I_C = f(V_{CE})$

Output characteristic Inverter (typical)

$T_{vj} = 125^\circ\text{C}$

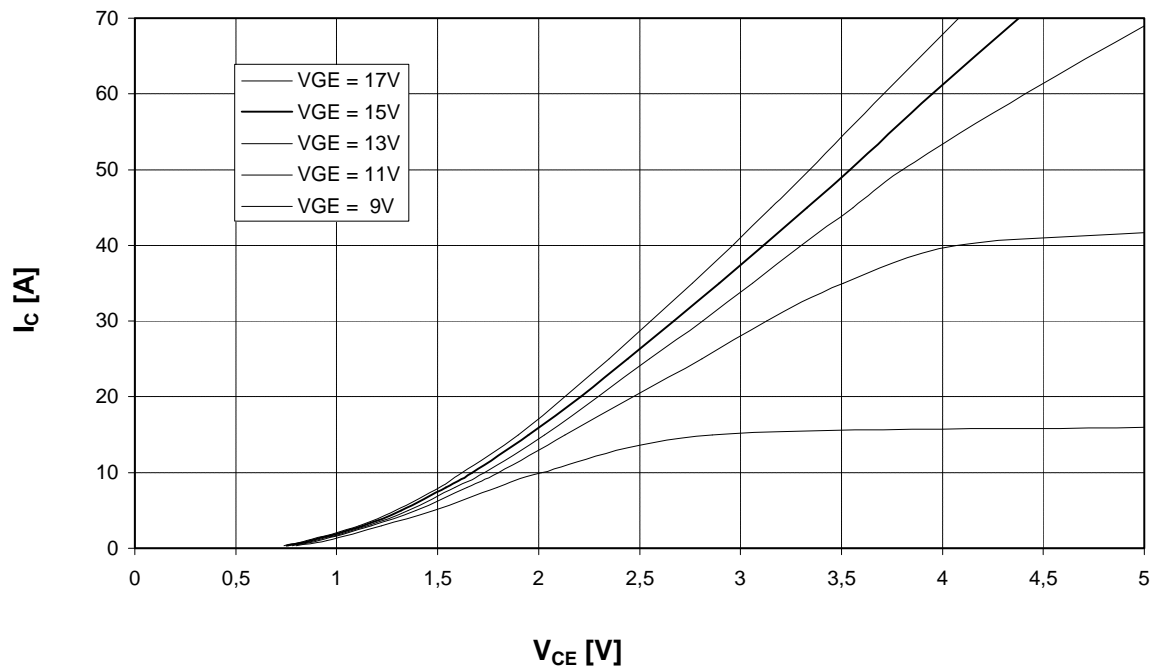



Übertragungscharakteristik Wechselr. (typisch)

$I_C = f(V_{GE})$

Transfer characteristic Inverter (typical)

$V_{CE} = 20\text{ V}$

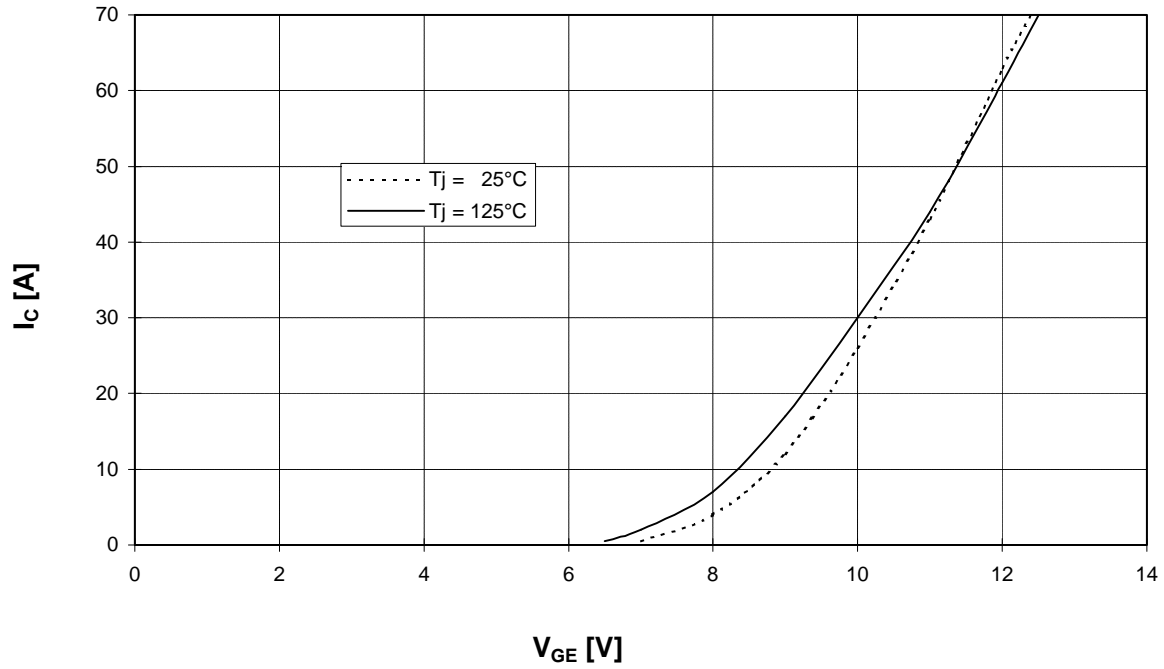

Durchlaßkennlinie der Freilaufdiode Wechselr. (typisch)

$I_F = f(V_F)$

Forward characteristic of FWD Inverter (typical)

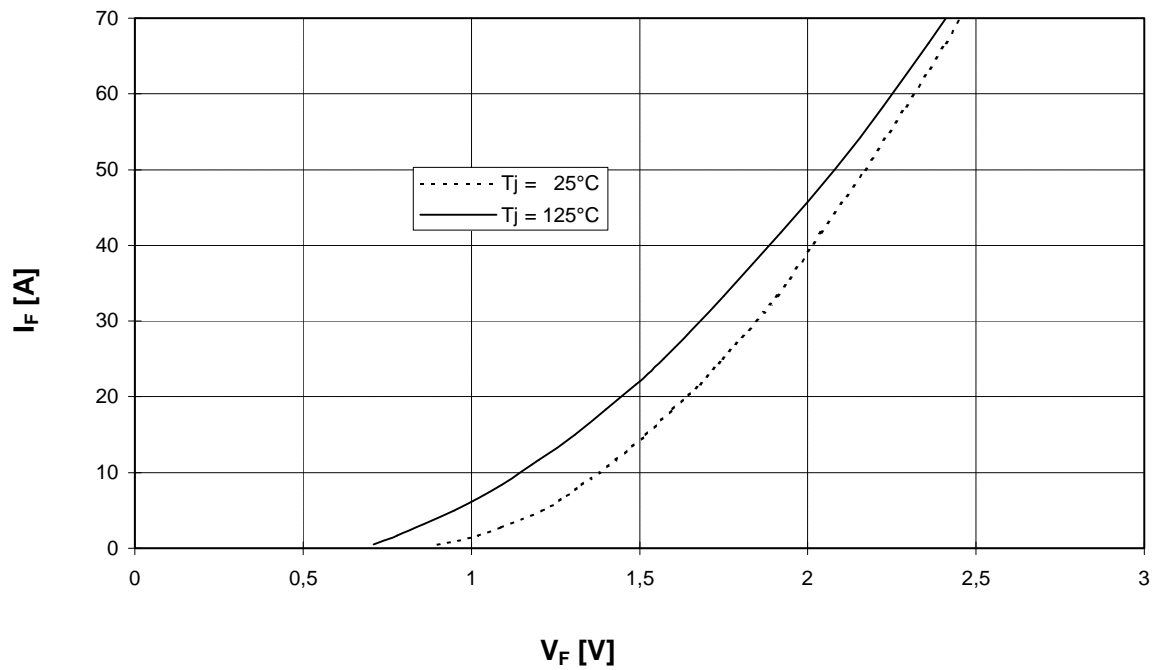

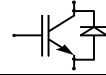

Schaltverluste Wechselr. (typisch)  $E_{on} = f(I_C), E_{off} = f(I_C), E_{rec} = f(I_C)$   $V_{CC} = 600\text{ V}$   
 Switching losses Inverter (typical)  $T_j = 125^\circ\text{C}, V_{GE} = \pm 15\text{ V}, R_{Gon} = R_{Goff} = 22\text{ Ohm}$

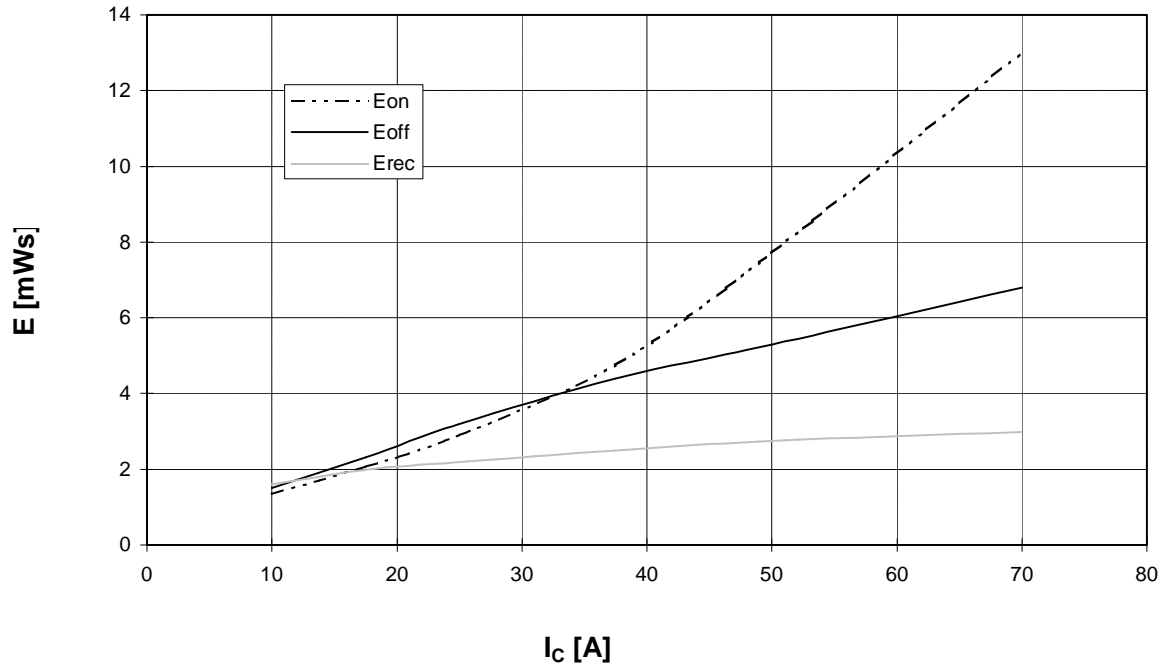

Schaltverluste Wechselr. (typisch)  $E_{on} = f(R_G), E_{off} = f(R_G), E_{rec} = f(R_G)$   
 Switching losses Inverter (typical)  $T_j = 125^\circ\text{C}, V_{GE} = \pm 15\text{ V}, I_c = I_{nenn}, V_{CC} = 600\text{ V}$

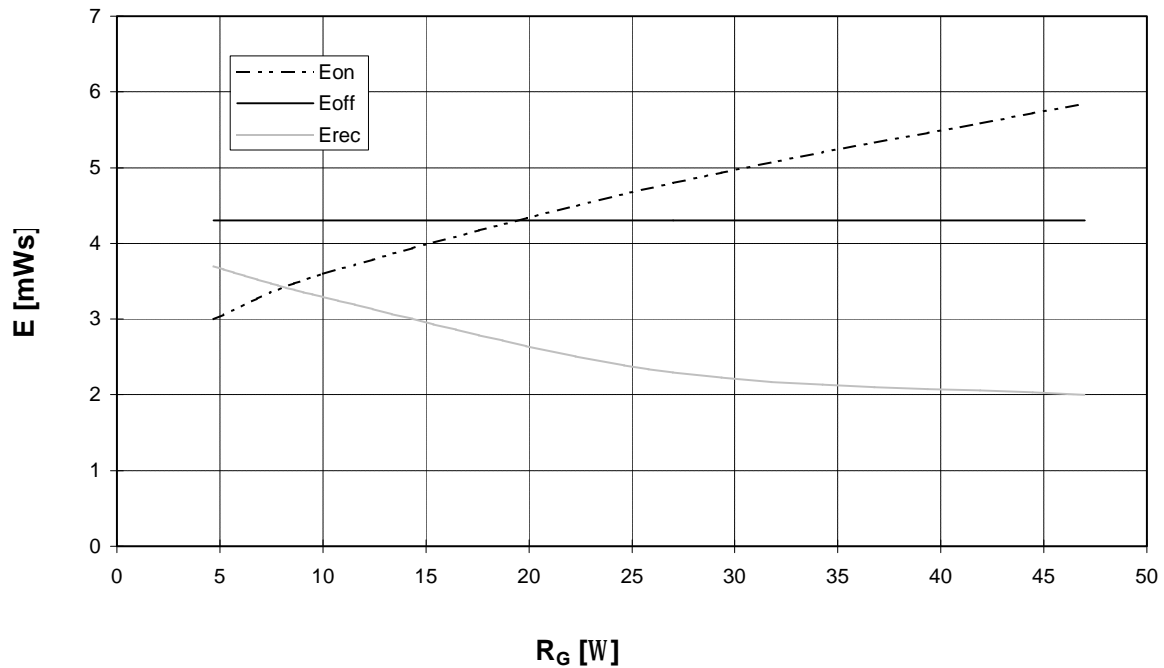



Transienter Wärmewiderstand Wechslr.  
Transient thermal impedance Inverter

$Z_{thJC} = f(t)$

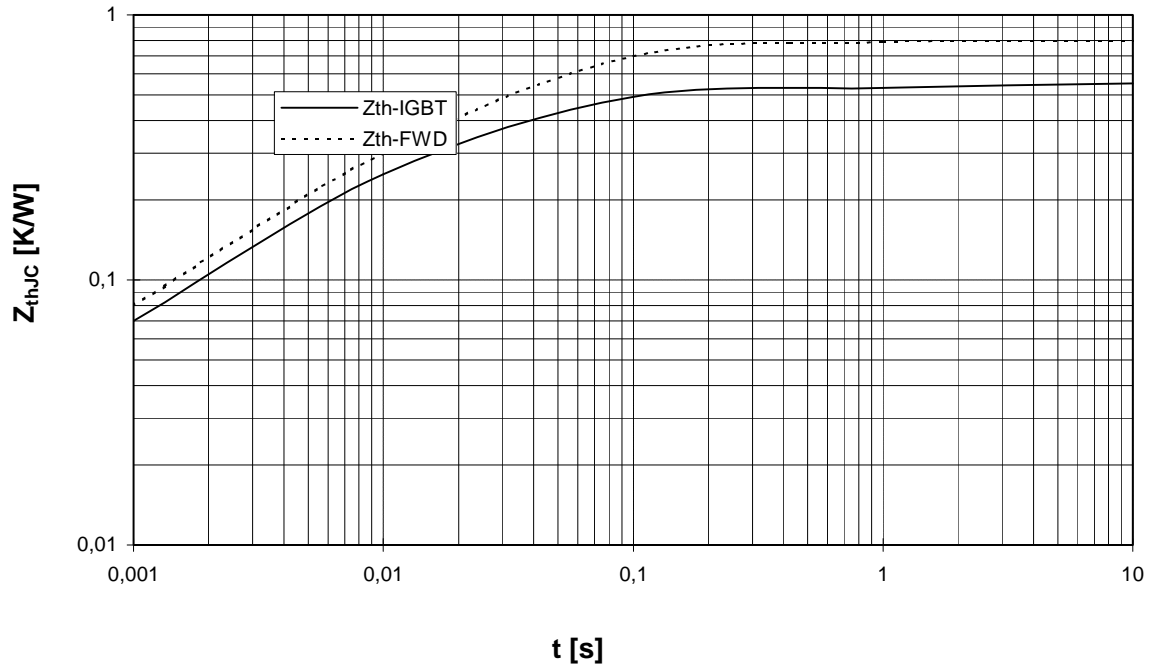

Sicherer Arbeitsbereich Wechslr. (RBSOA)

$I_C = f(V_{CE})$

Reverse bias safe operating area Inverter (RBSOA)  $T_{vj} = 125^\circ\text{C}$ ,  $V_{GE} = \pm 15\text{V}$ ,  $R_G = 22 \text{ Ohm}$

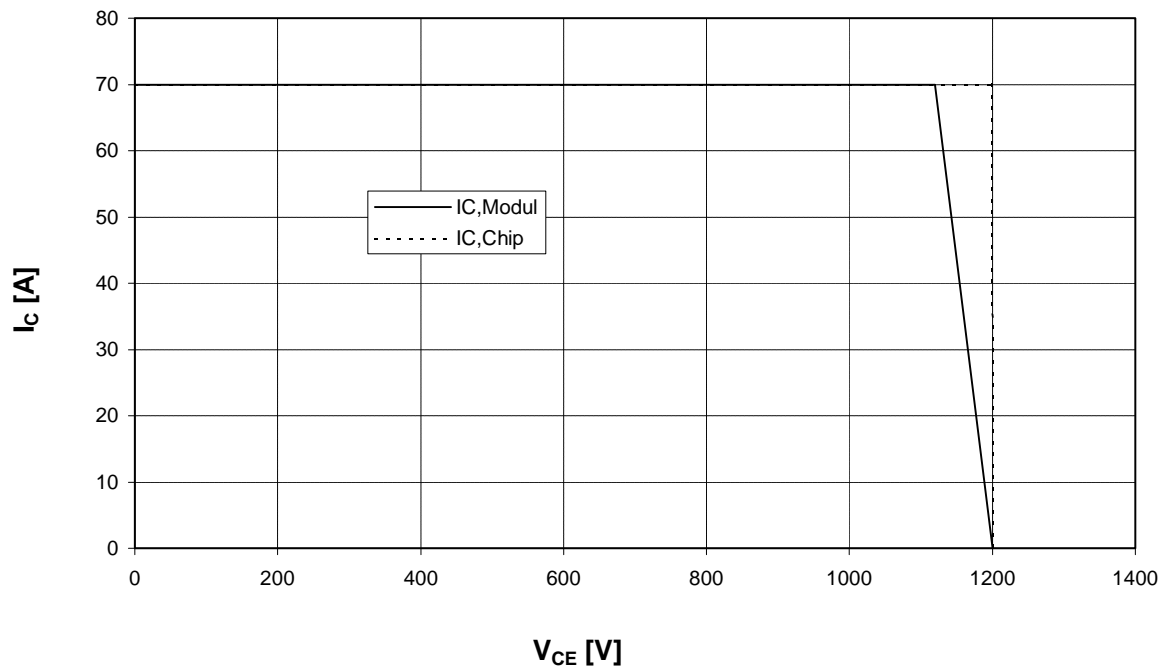





**Ausgangskennlinienfeld Brems-Chopper-IGBT (typisch)**

$I_C = f(V_{CE})$

**Output characteristic brake-chopper-IGBT (typical)**

$V_{GE} = 15\text{ V}$

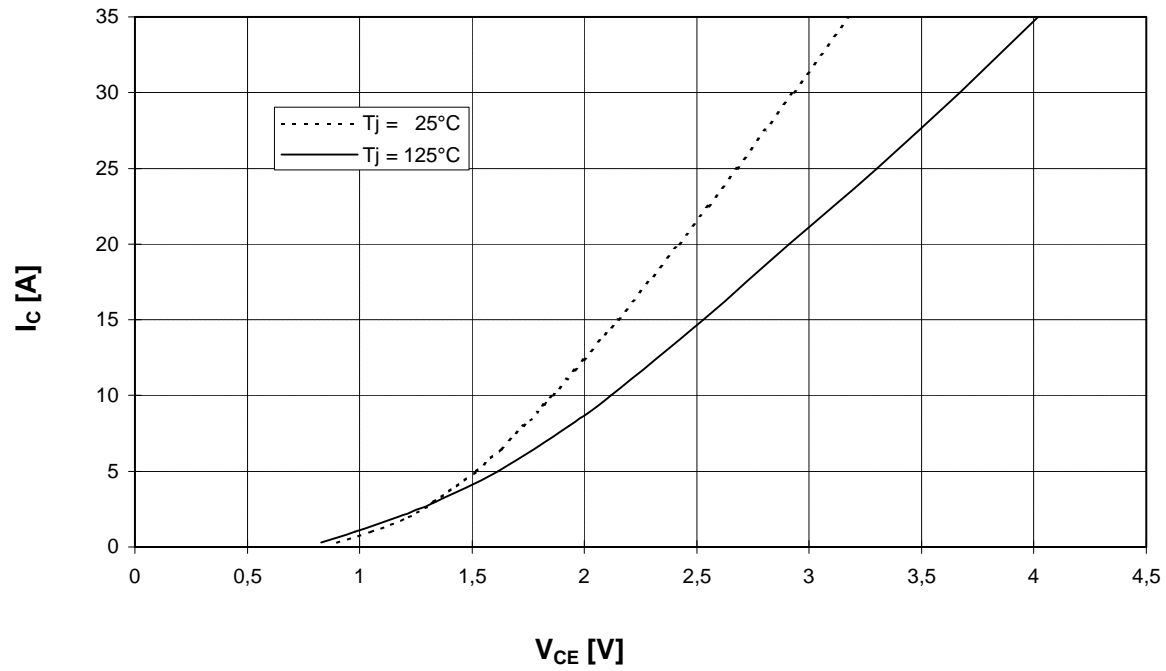

**Durchlaßkennlinie der Brems-Chopper-Diode (typisch)**

$I_F = f(V_F)$

**Forward characteristic of brake-chopper-FWD (typical)**

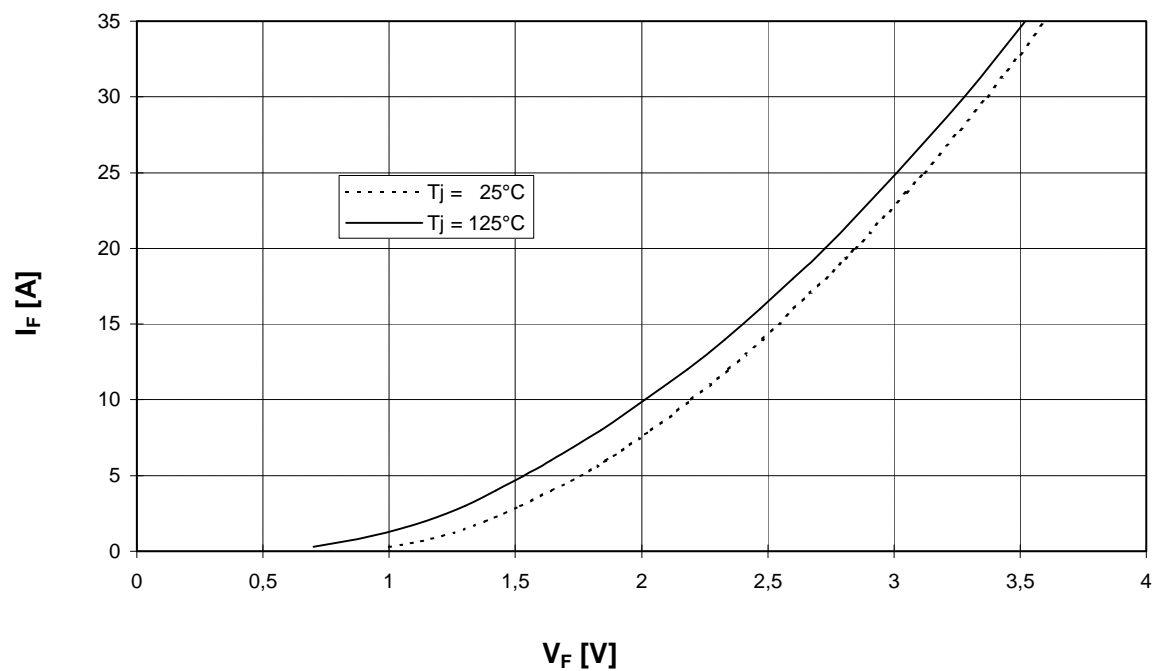



Durchlaßkennlinie der Gleichrichterdiode (typisch)  
Forward characteristic of Rectifier Diode (typical)

$I_F = f(V_F)$

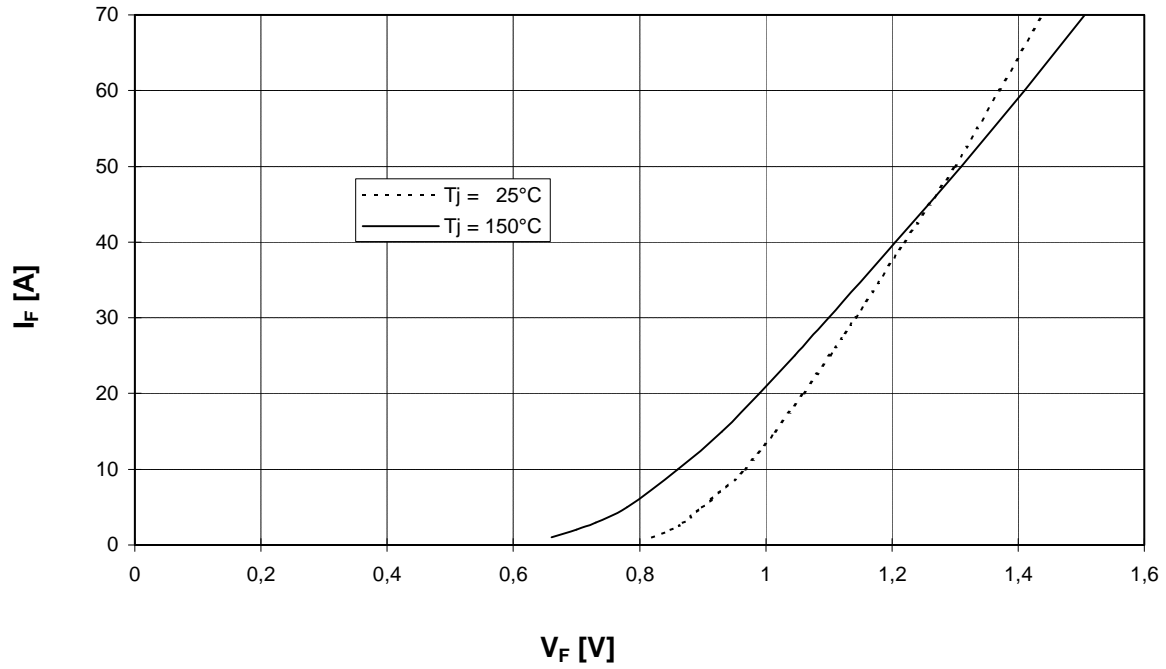

NTC- Temperaturkennlinie (typisch)

$R = f(T)$

NTC- temperature characteristic (typical)

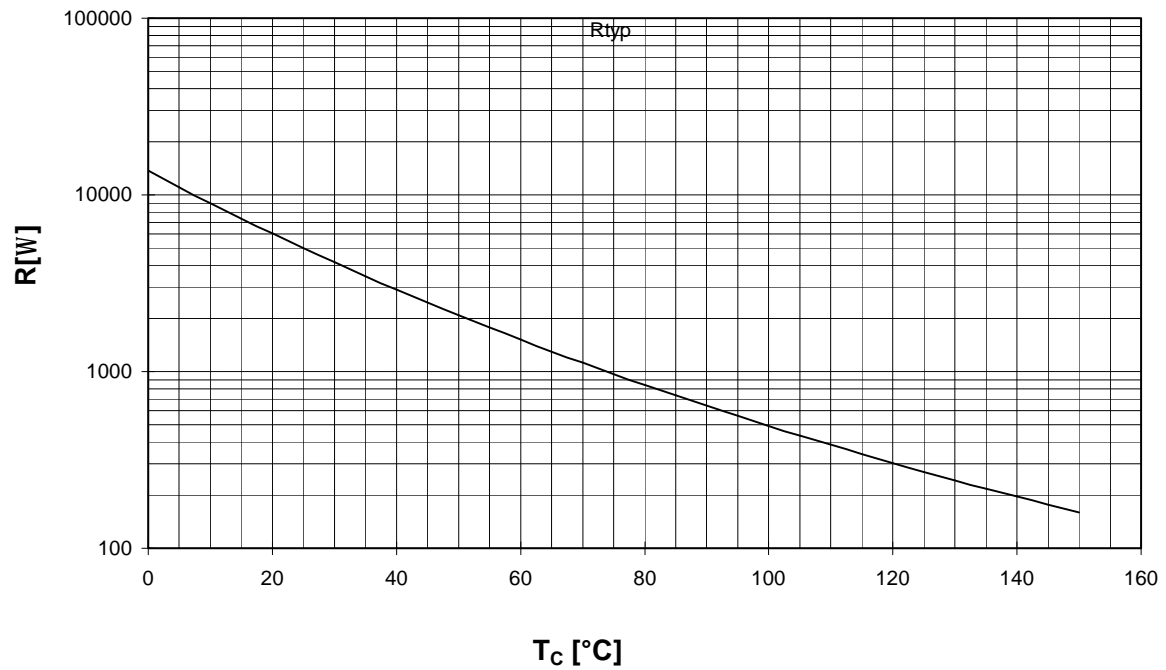

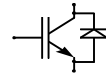

Schaltplan/ Circuit diagram

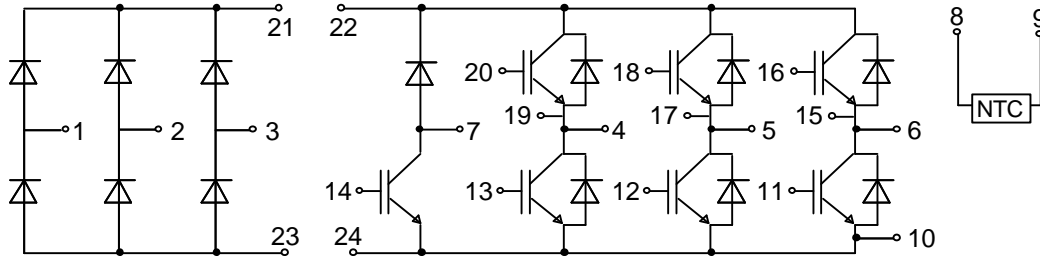

Gehäuseabmessungen/ Package outlines

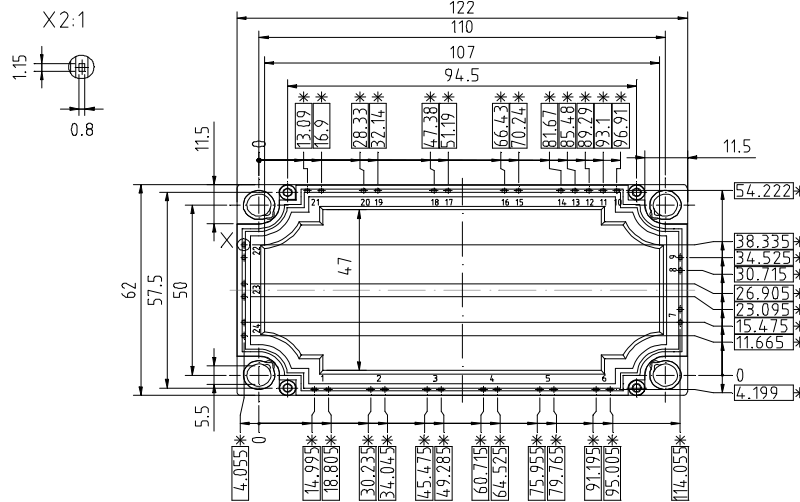
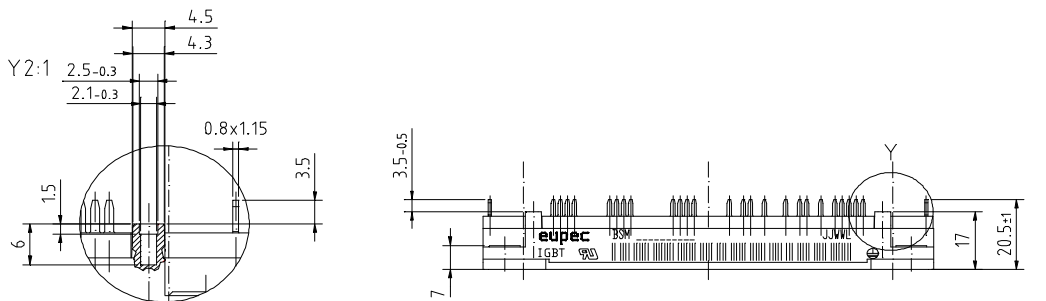

\* = alle Maße mit einer Toleranz von  $\pm 0.5$

Mit dieser technischen Information werden Halbleiterbauelemente spezifiziert, jedoch keine Eigenschaften zugesichert. Sie gilt in Verbindung mit den zugehörigen Technischen Erläuterungen.

This technical information specifies semiconductor devices but promises no characteristics. It is valid in combination with the belonging technical notes.